

The Straight Way

K Sileo Series



Systemair Sdn Bhd certifies that the K Sileo fans shown herein are licensed to bear the AMCA Seal. The ratings shown are based on tests and procedures performed in accordance with AMCA Publication 211 and AMCA Publication 311 and comply with the requirements of the AMCA Certified Ratings Program.



systemair

K Sileo Series

K-Fans

- Speed-controllable
- Quiet-running
- Increased efficiency
- Integral thermal contacts
- Can be installed in any position
- Can be installed outdoors
- Maintenance-free and reliable

The K Sileo series is designed for installation in ducts. All K-fans have a minimum 25 mm long spigot connections.

The fans have backward-curved blades and external rotor motors. To simplify the installation the K Sileo fan has a fixing bracket together with screws for mounting the bracket included as standard. The FK mounting clamp facilitates easy installation and removal, and prevents the transfer of vibration to the duct. The fans can be speed-controlled via a stepless thyristor or a 5-step transformer.

To protect the motor from overheating the fan has integral thermal contacts with manual reset.

The casing is manufactured from galvanised sheet steel and folded which gives the fan a close to air tight casing. Duct connected outdoor and wet room applications of the fan are possible due to the air tight casing



Technical data

50 Hz

		K 100 M Sileo	K 100 XL Sileo	K 125 M Sileo	K 125 XL Sileo	K 150 M Sileo	K 150 XL Sileo	K 160 M Sileo
Article No.		1001	25360	1002	25361	25362	25363	25364
Voltage	V	230	230	230	230	230	230	230
Frequency	Hz	50	50	50	50	50	50	50
Phase	-	1	1	1	1	1	1	1
Input power (P1)	W	30.7	52.1	28.2	52.7	53.3	100	53
Current	A	0.177	0.227	0.164	0.229	0.232	0.443	0.231
Max. airflow	m ³ /h	180	285	187	359	464	724	450
Fan impeller speed	r.p.m.	2407	2418	2491	2395	2379	2523	2388
Max. temperature of transported air	°C	70	70	70	70	70	70	70
Max. temperature of transported air when voltage controlled.	°C	70	70	70	70	70	70	70
Sound pressure level at 3 m (20m ³ Sabine)	dB(A)	33.5	45.2	34.2	41.7	37.5	46.4	37.8
Weight	kg	2.3	3	2.3	2.9	3.3	4.1	3.3
Insulation class		B	B	B	B	B	F	B
Enclosure class, motor	IP	44	44	44	44	44	44	44
Capacitor	µF	-	1.5	-	1.5	1.5	2.5	1.5

		K 160 XL Sileo	K 200 M Sileo	K 200 L Sileo	K 250 M Sileo	K 250 L Sileo	K 315 M Sileo+	K 315 L Sileo
Article No.		25365	25366	19510	25367	19512	19516	1012
Voltage	V	230	230	230	230	230	230	230
Frequency	Hz	50	50	50	50	50	50	50
Phase	-	1	1	1	1	1	1	1
Input power (P1)	W	102	102	145	103	145	201	324
Current	A	0.447	0.442	0.631	0.449	0.632	0.882	1.41
Max. airflow	m ³ /h	749	760	965	788	950	1238	1735
Fan impeller speed	r.p.m.	2539	2529	2555	2535	2555	2520	2403
Max. temperature of transported air	°C	70	70	70	70	70	70	57.4
Max. temperature of transported air when voltage controlled.	°C	70	70	70	70	70	70	52.4
Sound pressure level at 3 m (20m ³ Sabine)	dB(A)	46.4	42.7	47.8	41.3	46.8	46.4	51.5
Weight	kg	4	4.1	4.8	3.9	4.6	5.5	6.6
Insulation class		F	F	F	F	F	F	F
Enclosure class, motor	IP	44	44	44	44	44	44	44
Capacitor	µF	2.5	2.5	3.5	2.5	3.5	5	7

- Performance certified is for installation type D – Ducted inlet, Ducted outlet.
- Speed (RPM) shown is nominal. Performance is based on actual speed of test.
- Performance ratings do not include the effects of appurtenances (accessories).
- Sound pressure level at 3m (20m³ Sabine) are not licensed by AMCA International.

Performance

50 Hz

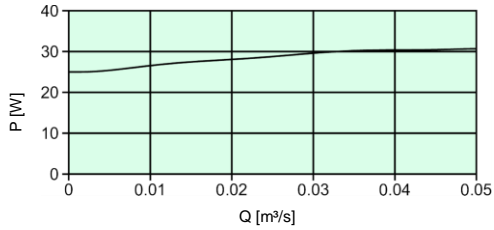
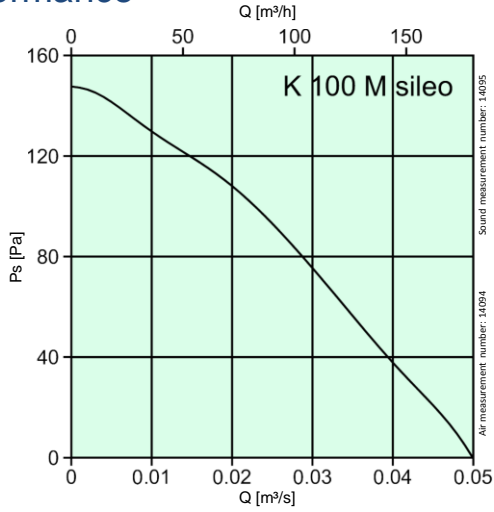

dB(A)	Tot	Frequency bands (Hz)							
		63	125	250	500	1K	2K	4K	8K
LwA Inlet	63	44	56	57	57	54	47	37	23
LwA Outlet	60	50	49	57	53	51	44	34	22
LwA Surrounding	41	16	18	23	37	38	30	16	11

Measurement point: 0.0231 m³/s and 99.3 Pa

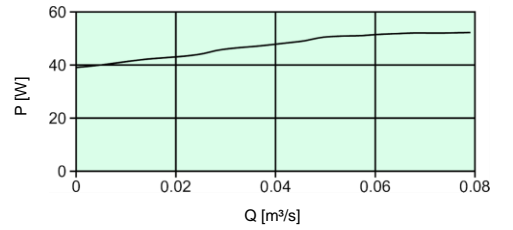
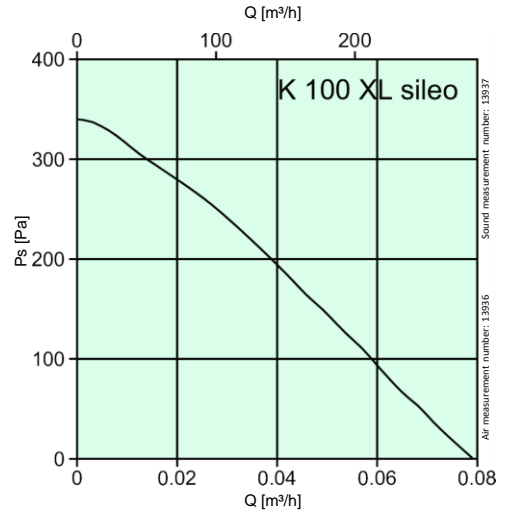

dB(A)	Tot	Frequency bands (Hz)							
		63	125	250	500	1K	2K	4K	8K
LwA Inlet	71	54	65	62	65	64	60	52	40
LwA Outlet	68	54	64	58	62	61	58	50	37
LwA Surrounding	54	29	30	39	50	49	46	38	25

Measurement point: 0.0375 m³/s and 206.6 Pa

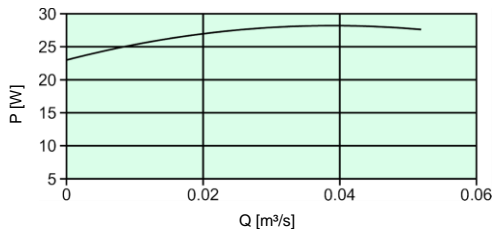
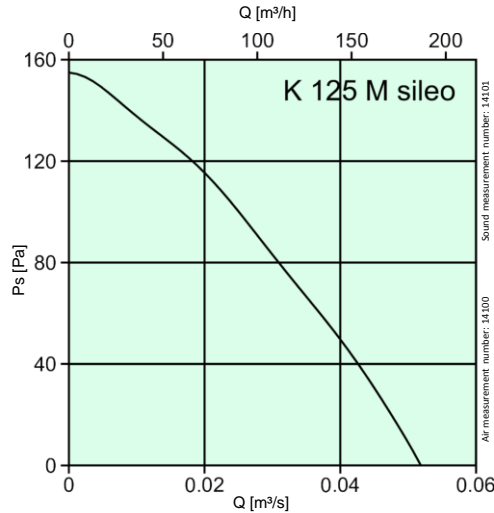

dB(A)	Tot	Frequency bands (Hz)							
		63	125	250	500	1K	2K	4K	8K
LwA Inlet	62	45	53	57	57	52	48	33	23
LwA Outlet	60	44	51	56	56	51	47	35	23
LwA Surrounding	40	16	26	31	36	35	31	19	13

Measurement point: 0.0267 m³/s and 94.5 Pa

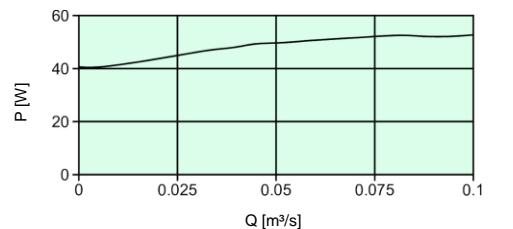
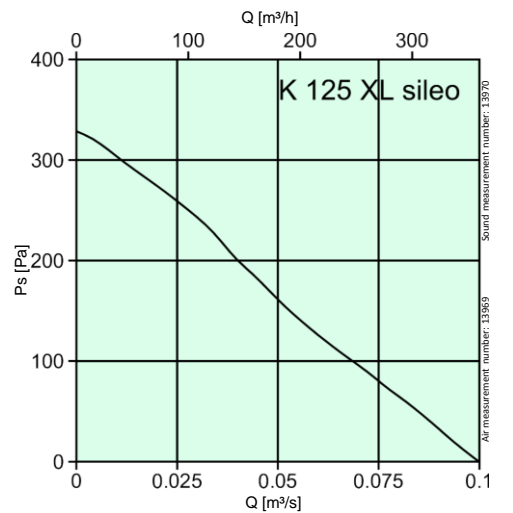

dB(A)	Tot	Frequency bands (Hz)							
		63	125	250	500	1K	2K	4K	8K
LwA Inlet	70	47	63	64	65	63	60	53	42
LwA Outlet	68	49	62	59	62	61	58	50	40
LwA Surrounding	49	18	17	38	45	42	42	36	28

Measurement point: 0.0397 m³/s and 201.5 Pa

The A-weighted sound ratings shown have been calculated per AMCA International Standard 301. Values shown are for inlet Lwi(A) and outlet Lwo(A) sound power levels for installation type D ducted inlet, ducted outlet. LwA Surrounding are not licensed by AMCA International. Ratings include the effects of duct end connection.

Performance certified is for installation type D- Ducted inlet. Ducted outlet. Speed (RPM) shown is nominal. Performance is based on actual speed of test. Performance ratings do not include the effects of appurtenances (accessories)

The sound power level rating shown are in decibel, referred to 10⁻¹² watts calculated per AMCA International Standard 301.

Performance

50 Hz

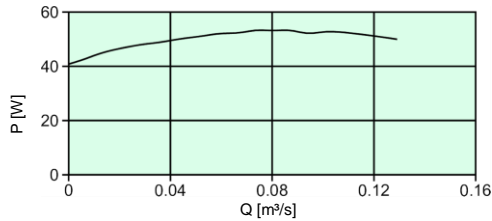
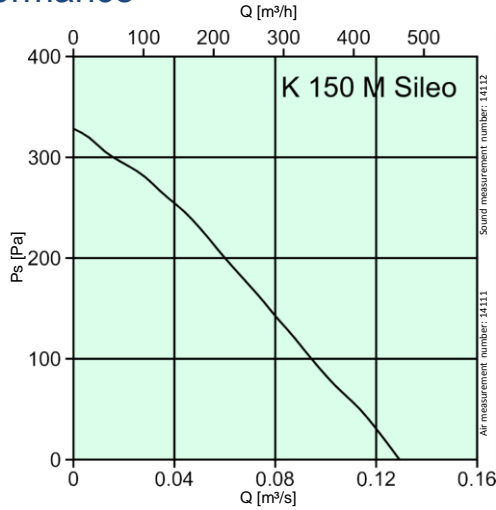

dB(A)	Tot	Frequency bands (Hz)							
		63	125	250	500	1K	2K	4K	8K
LwA Inlet	65	46	56	57	57	58	58	55	42
LwA Outlet	63	40	53	50	56	57	56	53	40
LwA Surrounding	45	19	12	28	38	39	39	40	29

Measurement point: 0.0664 m³/s and 182.2 Pa

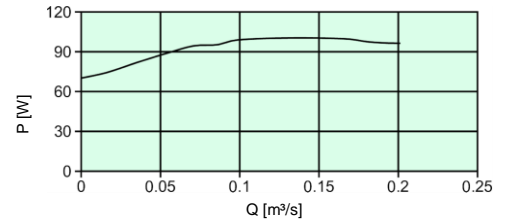
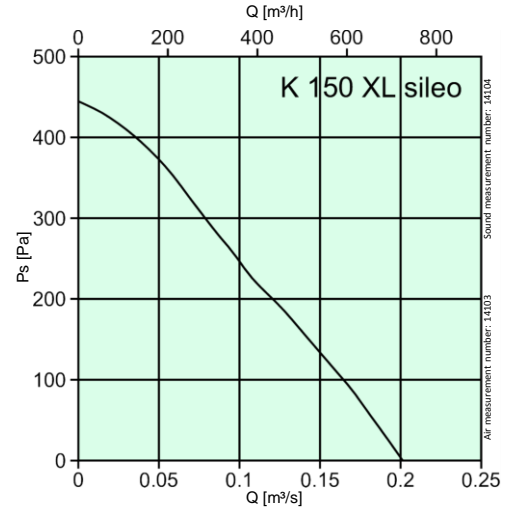

dB(A)	Tot	Frequency bands (Hz)							
		63	125	250	500	1K	2K	4K	8K
LwA Inlet	78	50	76	67	71	67	62	59	49
LwA Outlet	74	54	71	62	68	64	62	55	48
LwA Surrounding	53	14	33	37	50	46	47	44	29

Measurement point: 0.0864 m³/s and 280.4 Pa

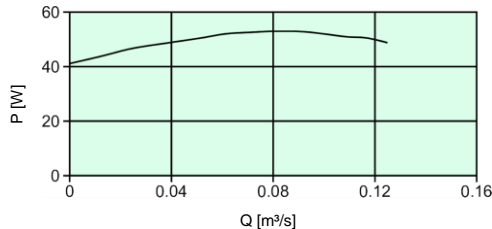
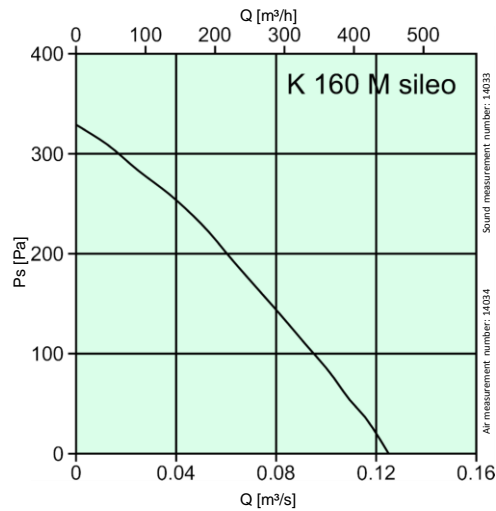

dB(A)	Tot	Frequency bands (Hz)							
		63	125	250	500	1K	2K	4K	8K
LwA Inlet	66	41	61	59	58	59	58	52	41
LwA Outlet	65	48	55	60	56	59	58	52	42
LwA Surrounding	45	17	21	32	39	38	40	34	23

Measurement point: 0.0525 m³/s and 223.4 Pa

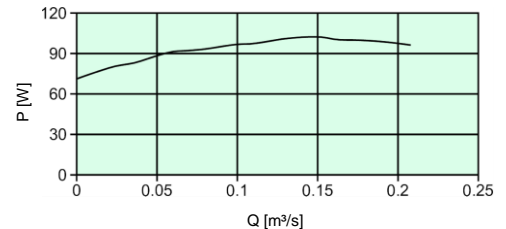
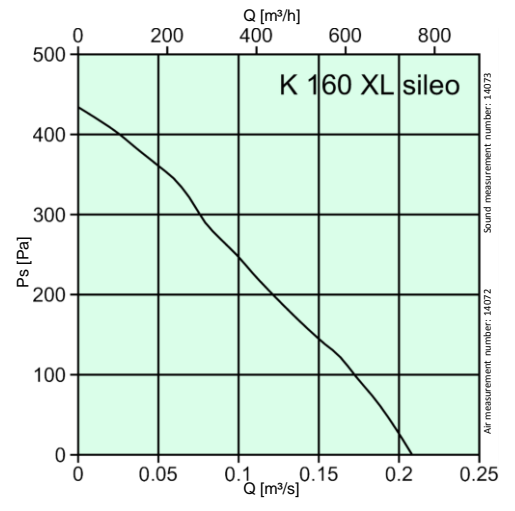

dB(A)	Tot	Frequency bands (Hz)							
		63	125	250	500	1K	2K	4K	8K
LwA Inlet	77	47	74	66	72	69	64	59	49
LwA Outlet	73	49	65	68	67	67	63	57	48
LwA Surrounding	53	9	32	36	50	47	47	43	29

Measurement point: 0.1006 m³/s and 246.0 Pa

The A-weighted sound ratings shown have been calculated per AMCA International Standard 301.

Values shown are for inlet Lw(A) and outlet Lwo(A) sound power levels for installation type D ducted inlet, ducted outlet. LwA Surrounding are not licensed by AMCA International.

Ratings include the effects of duct end connection.

Performance certified is for installation type D-Ducted inlet. Ducted outlet. Speed (RPM) shown is nominal. Performance is based on actual speed of test. Performance ratings do not include the effects of appurtenances (accessories)

The sound power level rating shown are in decibel, referred to 10⁻¹² watts calculated per AMCA International Standard 301.

Performance

50 Hz

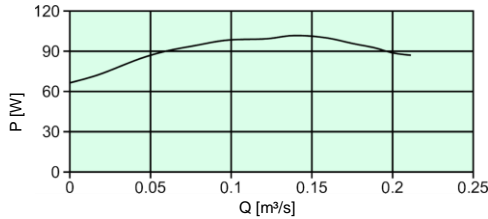
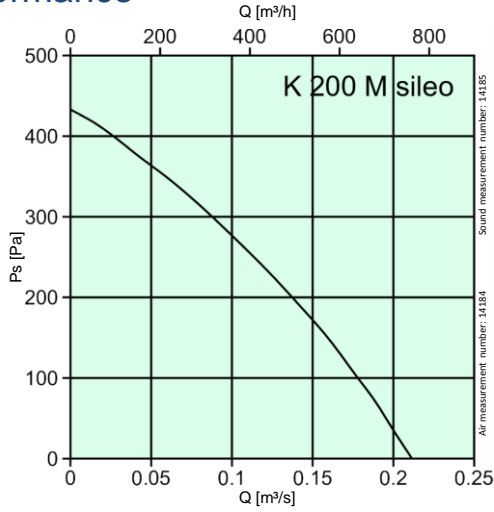

dB(A)	Tot	Frequency bands (Hz)							
		63	125	250	500	1K	2K	4K	8K
LwA Inlet	70	41	62	62	64	63	62	57	50
LwA Outlet	70	45	57	63	64	63	63	57	49
LwA Surrounding	50	13	23	37	46	43	43	38	29

Measurement point: 0.1231 m³/s and 230.8 Pa

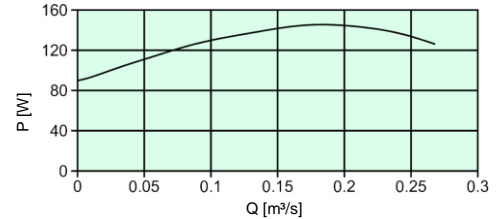
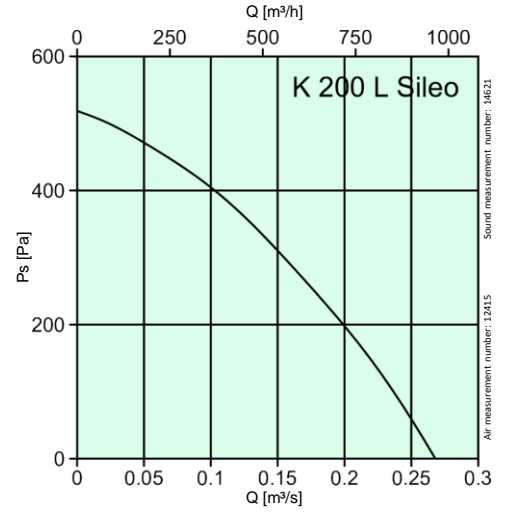

dB(A)	Tot	Frequency bands (Hz)							
		63	125	250	500	1K	2K	4K	8K
LwA Inlet	70	42	61	64	63	64	63	56	54
LwA Outlet	70	49	59	62	64	64	63	56	50
LwA Surrounding	50	5	24	32	41	46	46	39	35

Measurement point: 0.155 m³/s and 300 Pa

The A-weighted sound ratings shown have been calculated per AMCA International Standard 301. Values shown are for inlet Lw(A) and outlet Lwo(A) sound power levels for installation type D ducted inlet, ducted outlet, LwA Surrounding are not licensed by AMCA International. Ratings include the effects of duct end connection.

Performance certified is for installation type D-Ducted inlet. Ducted outlet. Speed (RPM) shown is nominal. Performance is based on actual speed of test. Performance ratings do not include the effects of appurtenances (accessories)

The sound power level rating shown are in decibel, referred to 10⁻¹² watts calculated per AMCA International Standard 301.

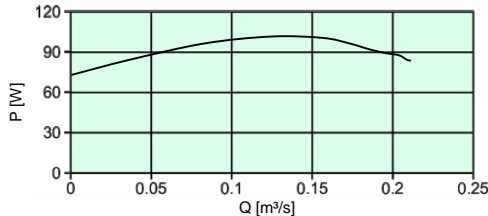
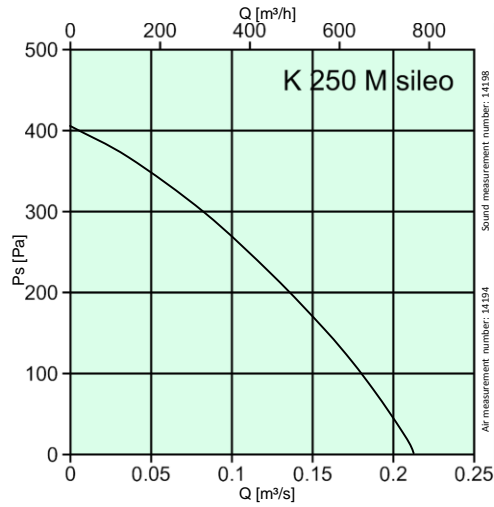

dB(A)	Tot	Frequency bands (Hz)							
		63	125	250	500	1K	2K	4K	8K
LwA Inlet	68	37	58	64	61	61	59	54	50
LwA Outlet	69	41	62	64	61	62	60	53	47
LwA Surrounding	48	9	28	41	43	43	39	37	33

Measurement point: 0.1358 m³/s and 215.2 Pa

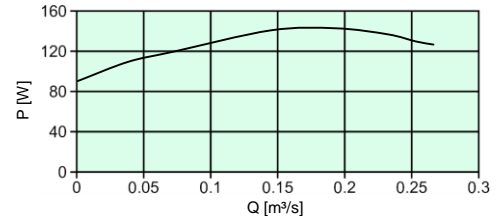
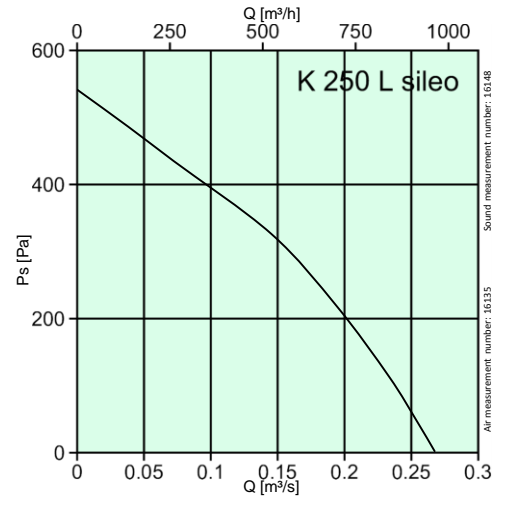

dB(A)	Tot	Frequency bands (Hz)							
		63	125	250	500	1K	2K	4K	8K
LwA Inlet	70	53	61	66	60	63	60	59	51
LwA Outlet	71	52	65	66	60	63	63	58	50
LwA Surrounding	48	18	34	42	43	41	40	33	27

Measurement point: 0.1520 m³/s and 321.0 Pa

Performance

50 Hz

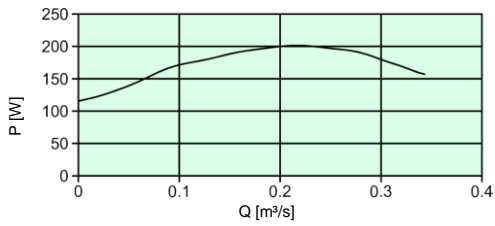
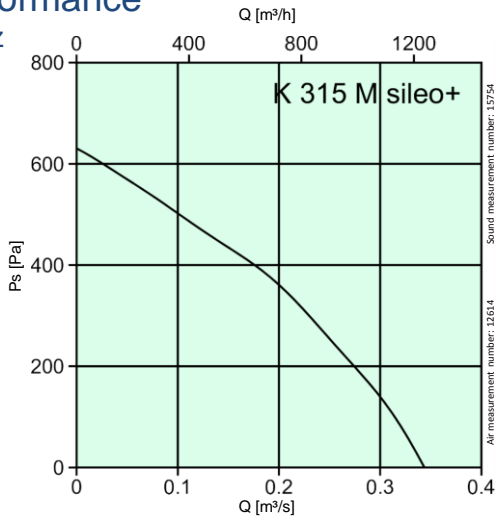

dB(A)	Tot	Frequency bands (Hz)							
		63	125	250	500	1K	2K	4K	8K
LwA Inlet	71	46	60	64	63	65	63	64	53
LwA Outlet	71	50	58	63	60	64	65	64	54
LwA Surrounding	53	16	25	43	46	44	48	46	31

Measurement point: 0.180 m³/s and 394.1 Pa

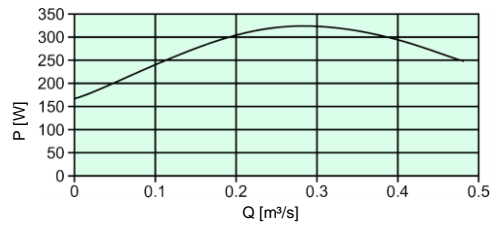
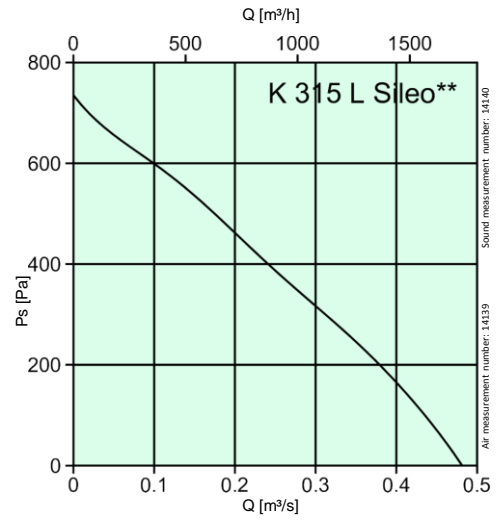

dB(A)	Tot	Frequency bands (Hz)							
		63	125	250	500	1K	2K	4K	8K
LwA Inlet	75	54	66	68	69	67	66	62	58
LwA Outlet	76	56	65	68	70	71	70	64	58
LwA Surrounding	59	27	34	50	56	46	50	46	39

Measurement point: 0.2231 m³/s and 427.1 Pa

SOUND DATA

The sound power level rating shown are in decibel, referred to 10⁻¹² watts calculated per AMCA International Standard 301.

Performance certified is for installation type D-Ducted inlet. Ducted outlet. Speed (RPM) shown is nominal. Performance is based on actual speed of test. Performance ratings do not include the effects of appurtenances (accessories)

The A-weighted sound ratings shown have been calculated per AMCA International Standard 301. Values shown are for inlet Lwi(A) and outlet Lwo(A) sound power levels for installation type D ducted inlet, ducted outlet. LwA Surrounding are not licensed by AMCA International. Ratings include the effects of duct end connection.

Technical data

60 Hz

		K 100 M Sileo	K 100 XL Sileo	K 125 M Sileo	K 125 XL Sileo	K 150 M Sileo	K 150 XL Sileo	K 160 M Sileo
Article No.		1001	25360	1002	25361	25362	25363	25364
Voltage	V	230	230	230	230	230	230	230
Frequency	Hz	60	60	60	60	60	60	60
Phase	-	1	1	1	1	1	1	1
Input power (P1)	W	33	65.1	31.6	66.5	66.7	138	66.3
Current	A	0.18	0.288	0.171	0.292	0.293	0.6	0.292
Max. airflow	m ³ /h	150	306	188	381	508	778	508
Fan impeller speed	r.p.m.	2073	2598	2165	2526	2525	2640	2538
Max. temperature of transported air	°C	70	70	70	70	70	70	70
Max. temperature of transported air when voltage controlled.	°C	70	70	70	70	70	70	70
Sound pressure level at 3 m (20m ³ Sabine)	dB(A)	39	47.9	30.8	42.5	38.8	48.2	40
Weight	kg	2.3	3	2.3	2.9	3.3	4.1	3.3
Insulation class		B	B	B	B	B	F	B
Enclosure class, motor	IP	44	44	44	44	44	44	44
Capacitor	µF	-	1.5	-	1.5	1.5	2.5	1.5

		K 160 XL Sileo	K 200 M Sileo	K 200 L Sileo	K 250 M Sileo	K 250 L Sileo	K 315 M Sileo+
Article No.		25365	25366	19510	25367	19512	19516
Voltage	V	230	230	230	230	230	230
Frequency	Hz	60	60	60	60	60	60
Phase	-	1	1	1	1	1	1
Input power (P1)	W	137	135	205	138	205	275
Current	A	0.596	0.592	0.891	0.606	0.895	1.2
Max. airflow	m ³ /h	810	842	1069	871	1098	1372
Fan impeller speed	r.p.m.	2701	2660	2706	2625	2677	2528
Max. temperature of transported air	°C	70	70	70	70	70	53.2
Max. temperature of transported air when voltage controlled.	°C	70	70	70	70	70	47.6
Sound pressure level at 3 m (20m ³ Sabine)	dB(A)	46.7	44.2	52.7	41.8	43.5	45.8
Weight	kg	4	4.1	4.8	3.9	4.6	5.5
Insulation class		F	F	F	F	F	F
Enclosure class, motor	IP	44	44	44	44	44	44
Capacitor	µF	2.5	2.5	3.5	2.5	3.5	5

- Performance certified is for installation type D – Ducted inlet, Ducted outlet.
- Speed (RPM) shown is nominal. Performance is based on actual speed of test.
- Performance ratings do not include the effects of appurtenances (accessories).
- Sound pressure level at 3m (20m³ Sabine) are not licensed by AMCA International.

Performance

60 Hz

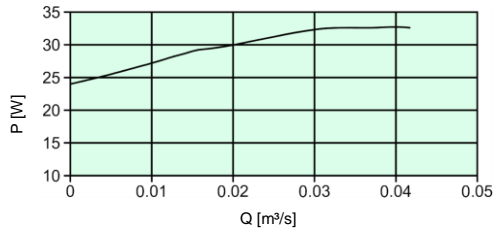
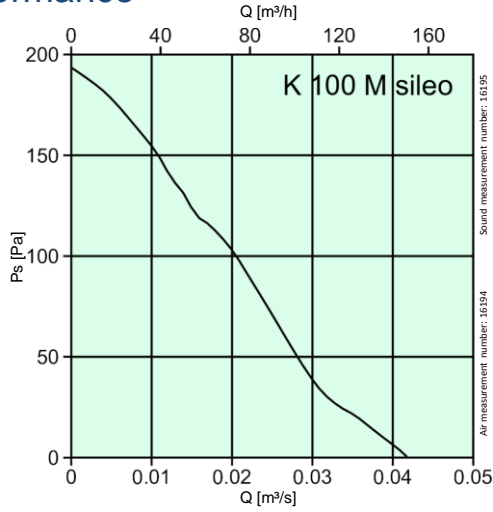

dB(A)	Tot	Frequency bands (Hz)							
		63	125	250	500	1K	2K	4K	8K
LwA Inlet	62	48	57	56	56	53	46	36	24
LwA Outlet	60	51	52	56	53	50	43	34	24
LwA Surrounding	40	21	21	20	37	36	29	16	13

Measurement point: 0.0202 m³/s and 102.1 Pa

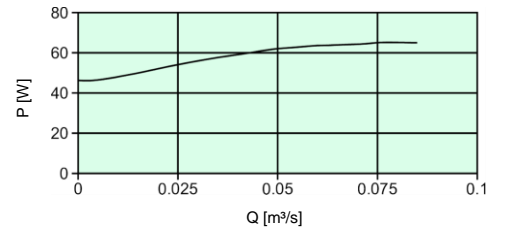
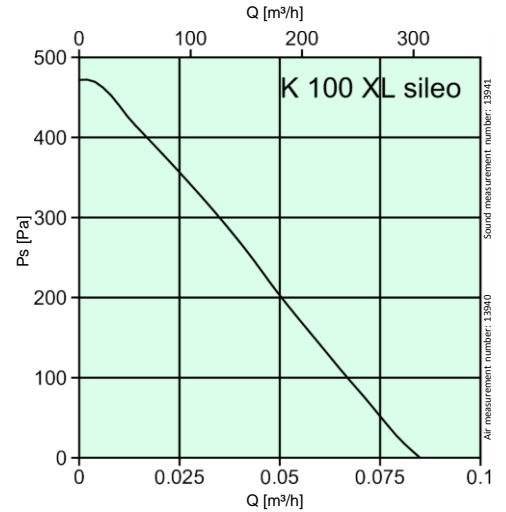

dB(A)	Tot	Frequency bands (Hz)							
		63	125	250	500	1K	2K	4K	8K
LwA Inlet	72	54	66	63	67	65	62	55	43
LwA Outlet	71	54	65	60	65	64	60	53	41
LwA Surrounding	55	25	29	34	51	49	48	41	27

Measurement point: 0.0419 m³/s and 275 Pa

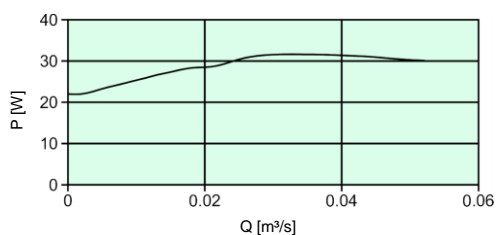
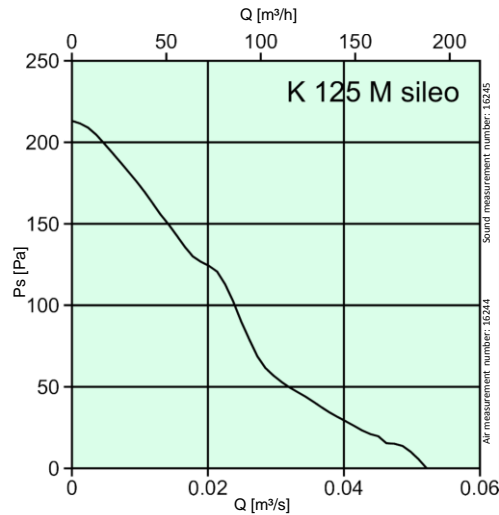

dB(A)	Tot	Frequency bands (Hz)							
		63	125	250	500	1K	2K	4K	8K
LwA Inlet	63	49	56	59	57	52	48	35	27
LwA Outlet	61	49	53	57	55	50	46	36	27
LwA Surrounding	40	23	33	18	33	36	30	21	15

Measurement point: 0.0214 m³/s and 120.4 Pa

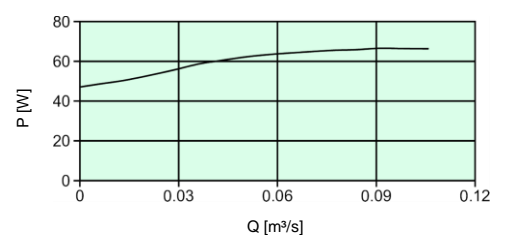
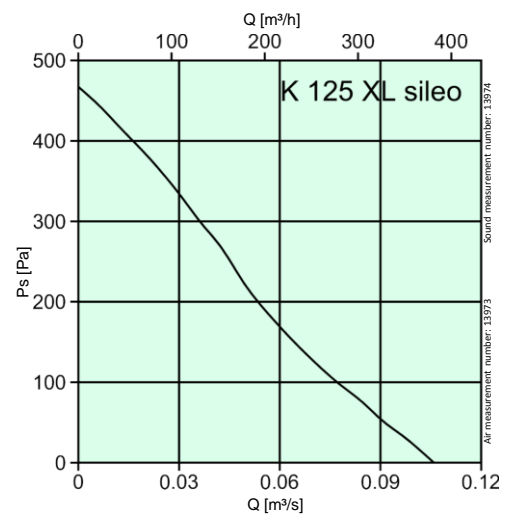

dB(A)	Tot	Frequency bands (Hz)							
		63	125	250	500	1K	2K	4K	8K
LwA Inlet	71	49	63	65	66	65	62	56	45
LwA Outlet	70	49	62	63	66	62	59	54	47
LwA Surrounding	49	19	23	36	45	43	44	38	27

Measurement point: 0.0419 m³/s and 271.3 Pa

The A-weighted sound ratings shown have been calculated per AMCA International Standard 301. Values shown are for inlet Lw(A) and outlet Lwo(A) sound power levels for installation type D ducted inlet, ducted outlet. LwA Surrounding are not licensed by AMCA International. Ratings include the effects of duct end connection.

Performance certified for installation type D-Ducted inlet. Ducted outlet. Speed (RPM) shown is nominal. Performance is based on actual speed of test. Performance ratings do not include the effects of appurtenances (accessories)

The sound power level rating shown are in decibel, referred to 10⁻¹² watts calculated per AMCA International Standard 301.

Performance

60 Hz

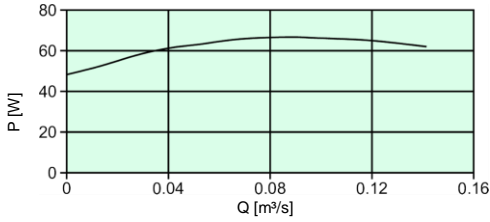
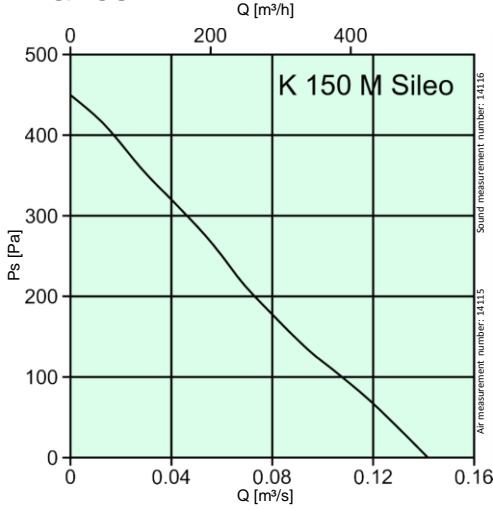

dB(A)	Tot	Frequency bands (Hz)							
		63	125	250	500	1K	2K	4K	8K
LwA Inlet	67	44	60	59	59	59	60	57	44
LwA Outlet	65	44	58	54	59	59	58	54	42
LwA Surrounding	47	13	18	30	40	40	41	41	30

Measurement point: 0.0597 m³/s and 251.7 Pa

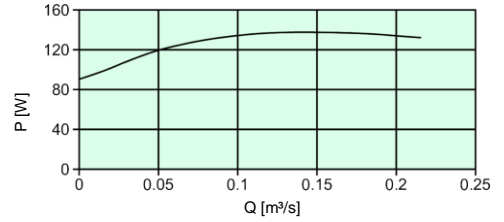
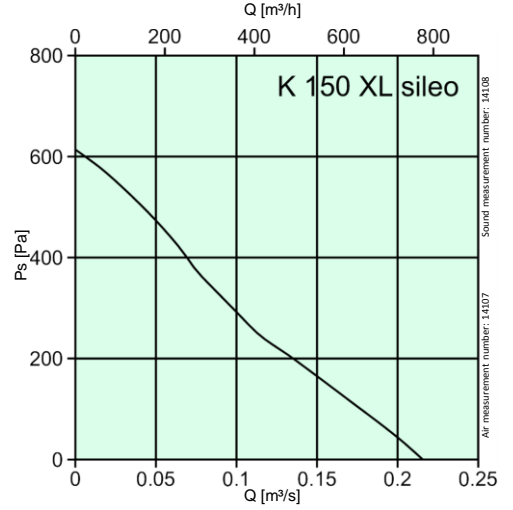

dB(A)	Tot	Frequency bands (Hz)							
		63	125	250	500	1K	2K	4K	8K
LwA Inlet	80	51	78	69	72	68	64	61	51
LwA Outlet	76	54	73	64	69	66	63	57	50
LwA Surrounding	55	10	37	38	52	46	49	46	32

Measurement point: 0.0881 m³/s and 331.1 Pa

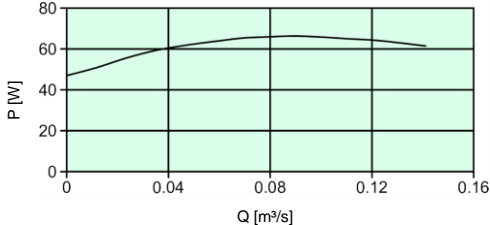
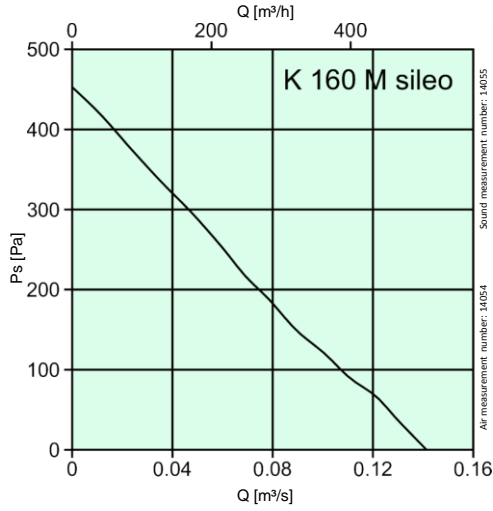

dB(A)	Tot	Frequency bands (Hz)							
		63	125	250	500	1K	2K	4K	8K
LwA Inlet	68	42	61	60	59	60	60	55	44
LwA Outlet	66	45	61	54	59	59	59	54	44
LwA Surrounding	47	15	22	34	43	39	42	36	25

Measurement point: 0.0597 m³/s and 253.2 Pa

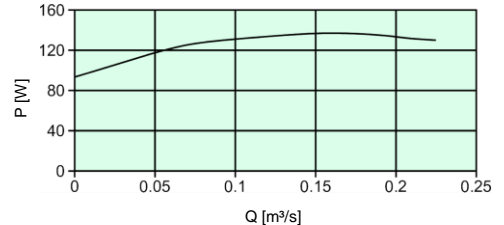
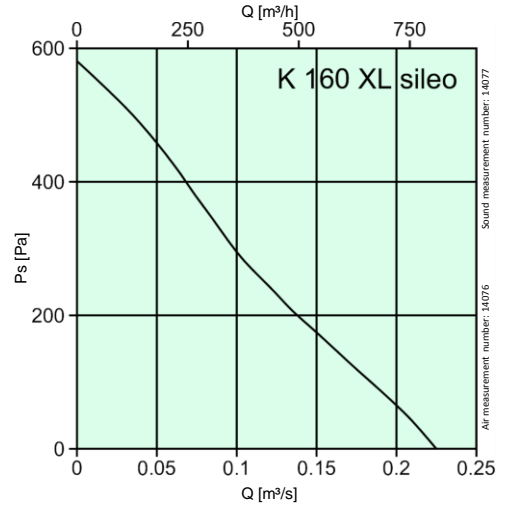

dB(A)	Tot	Frequency bands (Hz)							
		63	125	250	500	1K	2K	4K	8K
LwA Inlet	78	53	73	70	72	69	65	61	49
LwA Outlet	78	57	76	63	70	66	63	56	46
LwA Surrounding	54	13	31	36	50	47	48	44	29

Measurement point: 0.0833 m³/s and 349.8 Pa

The A-weighted sound ratings shown have been calculated per AMCA International Standard 301. Values shown are for inlet Lw(A) and outlet Lwo(A) sound power levels for installation type D ducted inlet, ducted outlet. LwA Surrounding are not licensed by AMCA International. Ratings include the effects of duct end connection.

Performance certified is for installation type D- Ducted inlet. Ducted outlet. Speed (RPM) shown is nominal. Performance is based on actual speed of test. Performance ratings do not include the effects of appurtenances (accessories)

The sound power level rating shown are in decibel, referred to 10⁻¹² watts calculated per AMCA International Standard 301.

Performance

60 Hz

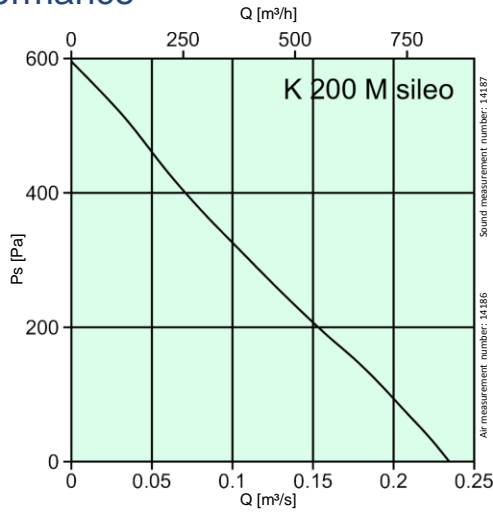

Sound measurement number: 14187
Air measurement number: 14186

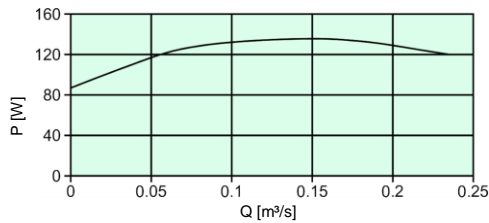

dB(A)	Tot	Frequency bands (Hz)							
		63	125	250	500	1K	2K	4K	8K
LwA Inlet	73	46	67	65	67	65	64	57	49
LwA Outlet	71	51	60	64	66	64	64	58	50
LwA Surrounding	51	17	30	38	48	46	43	39	28

Measurement point: 0.1022 m³/s and 320.77 Pa

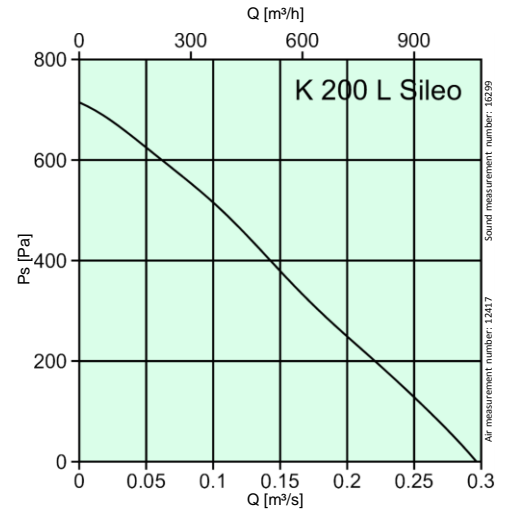

Sound measurement number: 16299
Air measurement number: 12417

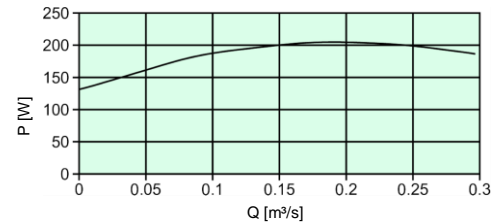

dB(A)	Tot	Frequency bands (Hz)							
		63	125	250	500	1K	2K	4K	8K
LwA Inlet	73	46	67	69	65	65	63	55	50
LwA Outlet	71	54	66	62	64	63	62	56	50
LwA Surrounding	56	9	33	44	49	52	51	47	41

Measurement point: 0.1206 m³/s and 462.7 Pa

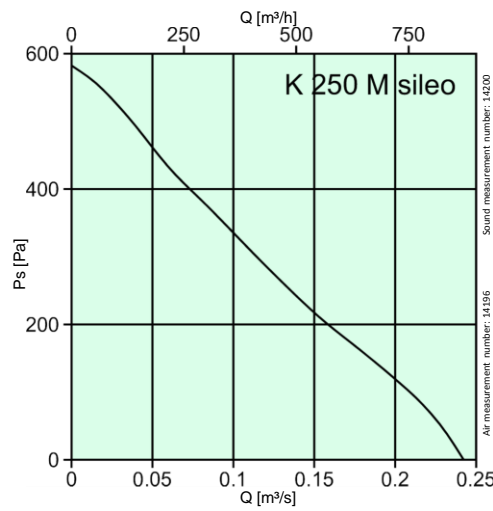

Sound measurement number: 14200
Air measurement number: 14195

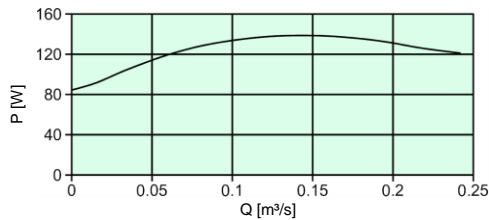

dB(A)	Tot	Frequency bands (Hz)							
		63	125	250	500	1K	2K	4K	8K
LwA Inlet	70	44	65	64	63	62	60	55	48
LwA Outlet	71	44	65	65	62	63	61	54	48
LwA Surrounding	49	13	34	38	45	43	39	38	30

Measurement point: 0.1222 m³/s and 281.2 Pa

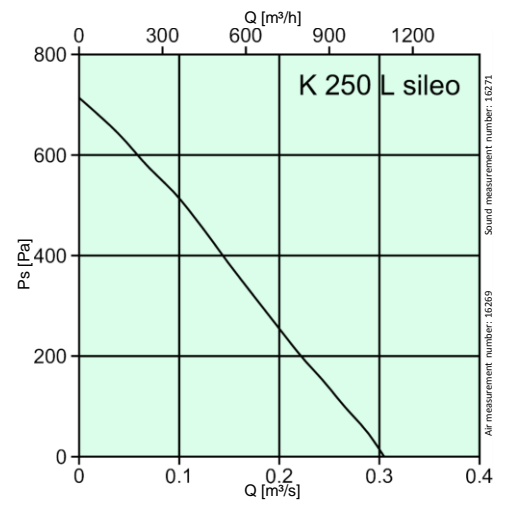

Sound measurement number: 16271
Air measurement number: 16269

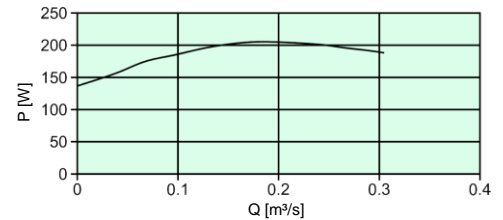

dB(A)	Tot	Frequency bands (Hz)							
		63	125	250	500	1K	2K	4K	8K
LwA Inlet	72	51	67	67	63	65	62	56	50
LwA Outlet	71	57	65	61	63	64	64	57	51
LwA Surrounding	50	25	47	38	43	41	42	35	27

Measurement point: 0.1247 m³/s and 451.16 Pa

The A-weighted sound ratings shown have been calculated per AMCA International Standard 301. Values shown are for inlet Lwi(A) and outlet Lwo(A) sound power levels for installation type D ducted inlet, ducted outlet, LwA Surrounding are not licensed by AMCA International. Ratings include the effects of duct end connection.

Performance certified is for installation type D- Ducted inlet. Ducted outlet. Speed (RPM) shown is nominal. Performance is based on actual speed of test. Performance ratings do not include the effects of appurtenances (accessories)

The sound power level rating shown are in decibel, referred to 10⁻¹² watts calculated per AMCA International Standard 301.

Performance

60 Hz

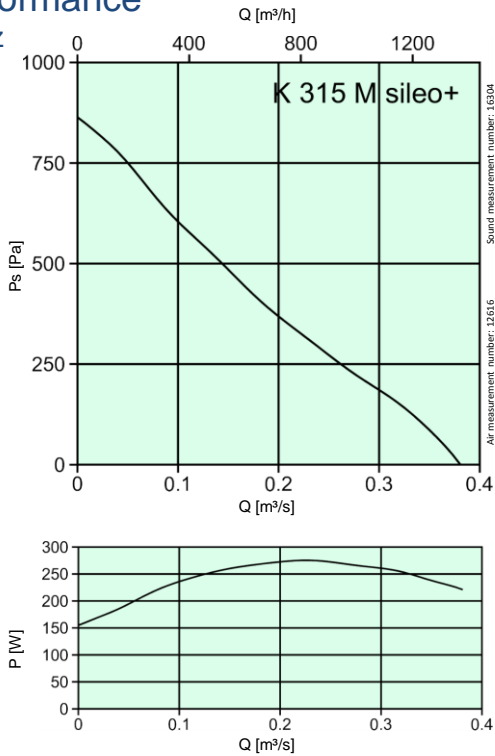

dB(A)	Tot	Frequency bands (Hz)							
		63	125	250	500	1K	2K	4K	8K
LwA Inlet	72	54	66	63	64	66	64	64	54
LwA Outlet	72	61	57	65	62	66	67	63	54
LwA Surrounding	52	35	35	38	45	40	47	45	31

Measurement point: 0.1557 m³/s and 477,3 Pa

SOUND DATA

The sound power level rating shown are in decibel, referred to 10⁻¹² watts calculated per AMCA International Standard 301.

Performance certified is for installation type D-Ducted inlet. Ducted outlet. Speed (RPM) shown is nominal. Performance is based on actual speed of test. Performance ratings do not include the effects of appurtenances (accessories)

The A-weighted sound ratings shown have been calculated per AMCA International Standard 301. Values shown are for inlet Lwi(A) and outlet Lwo(A) sound power levels for installation type D ducted inlet, ducted outlet. LwA Surrounding are not licensed by AMCA International. Ratings include the effects of duct end connection.

Dimensions

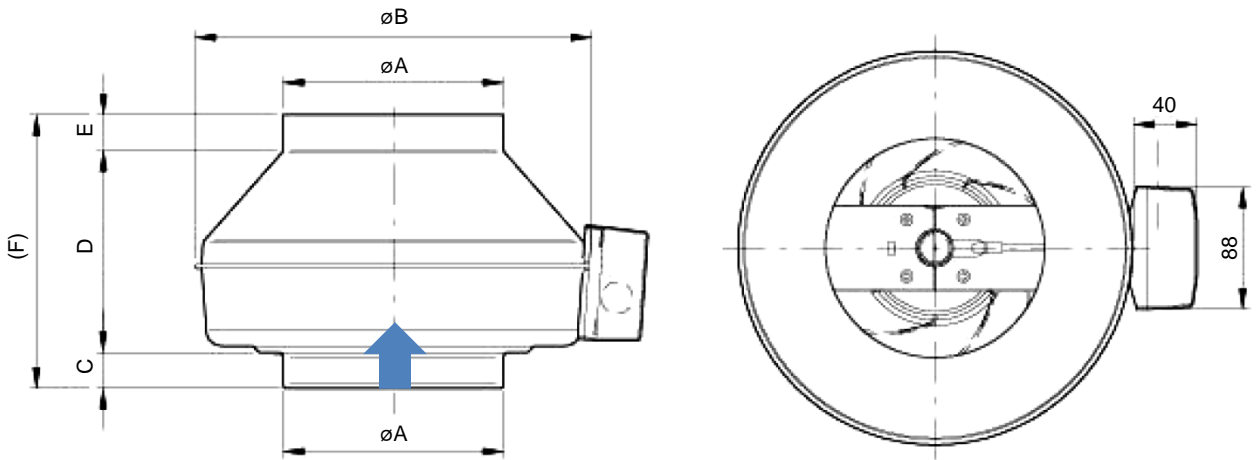

IN METRIC

K	Aø	Bø	C	D	E	(F)
100 M SILEO	99	210	26	166	26	218
100 XL SILEO	99	246	26	161	26	213
125 M SILEO	124	218	27	142	27	196
125 XL SILEO	124	246	26	151	26	203
150 M SILEO	149	286	25	152	25	202
150 XL SILEO	149	336	29	171	26	226
160 M SILEO	159	286	25	147	16	198
160 XL SILEO	159	336	29	166	26	221
200 M SILEO	199	336	30	148	27	205
200 L SILEO	199	336	30	174	27	231
250 M SILEO	249	336	30.5	119.5	27	177
250 L SILEO	249	336	30.5	144.5	27	202
315 M SILEO	314	408	32.5	160.5	27	220
315 L SILEO	314	408	37.5	160.5	27	22.5

NO LIABILITY FOR ERRORS – SUBJECT TO TECHNICAL MODIFICATIONS

Electrical accessories



VBC 315-3 Water heating battery

Art no: 9844

Water-heating battery for heating air in ventilation systems with circular ducts. Aluzinc-coated casing, heat transmission element with copper tubes and aluminium fins. Removable cover for cleaning the unit.

The water-heating battery can be installed in a horizontal or a vertical duct with optional direction of airflow.

Max operating temperature 150 °C

Max operating pressure 1,6 MPa (16Bar)

3-rows battery



RETP 6 Temp/Pressure regulator

Art no: 32293

Pressure/Temperature regulation, single phase

Thyristor-type stepless pressure or temperature regulation (P-regulation) for single-phase motors with variable voltage control. Used, for example, for room-temperature regulation where the heating is conducted by air. An integral motor protection device is included which switch off the supply voltage to the fan if the thermal contact in the fan motor is activated.



REV-3POL/03 ON/OFF

Art no: 33978

REV- Isolator mounted on a bracket, leads connected I max 20 A.

- 3POL/03

3-pole (closing/auxillary contact 1) lead 3x1,5 mm² for 1 phase motor. TK not lead out

When operating with Explosion proof fans the REV has to be placed outside the EX zone!



RE 1,5 Speed control

Art no: 5000

Manual five-step transformer

A single-phase transformer which controls the fan speed by altering the supply voltage in five fixed steps. The steps are adjusted manually, using the control knob on the front of the unit. The transformer has 230V terminals for operating dampers, electric heater batteries or other external equipment. When the transformer knob is in position 0, the outlet has no current. The indicator lamp on the front shows that the transformer is in operation. The fuse may be reset from outside. The RE has a self extinguishing thermoplastic casing.

NOTE! Fans with external contact leads (TK) must always be connected to a motor protection device.



REU 1.5 Speed control

Art no: 5004

Manual five-step transformer

A single-phase transformer which controls the fan speed by altering the supply voltage in five fixed steps. The steps are adjusted manually, using the control knob on the front of the unit. There are two control switches: one for higher fan speeds and one for lower fan speeds. Switching between the high and low settings is done by an external change-over contact, which could be a thermostat or a timer. The indicator lamp on the front shows when the transformer is in operation. The fuse may be reset from outside. The REU has a self-extinguishing thermoplastic casing. Supply voltage: 230V 50/60Hz.

NOTE! Fans with external thermal contact leads (TK) must always be connected to a motor protection device.



DTV500-OEM including connection kit

Art no: 5044

Differential pressure switch for air and non-corrosive gasses. Relay contact data 250 V AC 5 A, change-over.

Electrical accessories



HR1 Room Humidistat IP21

Art no: 5150

Room humidistat

A humidistat for controlling exhaust air fans in response to the relative humidity. The humidistat uses human hair as the humidity sensor medium. The set-point can be anywhere between 10 and 95% RH. Base plate in black plastic and cover in white plastic.

The HR1 is supplied with a sliding cover over the set-point dial, which can be locked.

The humidistat should be mounted in a location with good air circulation and constant temperature and humidity. It should not be fitted on external walls, walls in direct sunlight, corners etc.

The humidistat's mounting holes make it suitable for fixing on to a terminal box with screws at 60 mm centers.

The humidistat should be precision-calibrated after it has been mounted, and should be recalibrated regularly. Dust and other matter should be removed with a soft brush at regular intervals.

Contacts 1 and 3 close when the air humidity exceeds the preset value.



RT 0-30 Room Thermostat

Art no: 5151

The RT 0-30 is an electronic room thermostat for indoor wall mounting, with a change-over relay for regulating either heating or cooling. It has an integral sensor, but an external sensor such as the TG-K330 or TG-R630 can also be connected to the thermostat. The RT 0-30 can also be used with other external temperature sensors to achieve different temperature range.



T 120 Timer

Art no: 5165

Timer with 120-minute operating time. Supplied with flange for fitting into equipment housing. Casing for surface mounting is available as an extra. A switch for closing and breaking circuits. A link can be used to produce a change-over function. The timer makes a quiet ticking sound when connected.

This timer is suitable for controlling the REU and RTRDU five step transformers.



REE 2 Speed control

Art no: 5316

Thyristor speed controller

- REE 1 or REE 2 surface- or flush mounting

- REE 4 only surface mounting

For the manual control of speed and air flow of electrical fans, AC-induction motors of universal motor- and permanent-capacitor type. The jetproof IP 54 enclosure is achieved with the included surface mounting case. (Flush mounting without the surface mounting case, gives a splash proof IP 44 enclosure also suitable for highly demanding environments as bathrooms etc.) Several motors can be connected in parallel as long as the total current does not exceed current range. Starting currents must be considered when choosing speed controller type. Fans to be used with this controller require a built-in overheating protection and should be designed for thyristor speed control.



REPT 6 Digital regulator

Art no: 5698

Digital voltage regulation, single phase

Thyristor-type digital regulation for single-phase motors with variable voltage control. Used, for example, for the pressure regulation of fans in systems where there is a risk of increased draught, and compensation is required for outdoor temperature conditions and other pressure conditions. An integral motor protection device is included which cuts the supply voltage to the fan if the thermal contact in the fan motor is activated.

Radio interference suppression in accordance with EN 50081-1 and EN 50082-2.

Electrical accessories



CO2RT-R-D Transmitter

Art no: 6993

Measuring system CO2-sensor

The CO₂-concentration is measured by means of infrared light, a technique that measures the absorption in gases. It has a reference measuring system that compensates values in relation to changes in light intensity. The method gives several advantages:

- Very high accuracy
- Exact identification of the detected gas
- Low risk for contamination
- Short response time
- High long term stability
- Long calibration interval (>5 years)

Display

The display models have an LCD-display showing actual values in an alternated series.

Applications

Measuring the CO₂-level gives a direct indication about the indoor air quality. With this basic information ventilation can be controlled with high precision and air quality improved. At the same time supply air will only be increased when it is necessary thus cutting energy costs.



Presence detector/IR24-P

Art no: 6995

Presence detector

A detector that gives a signal when someone is present in the room under supervision. The detector has a pulse detecting function that minimizes the risk for false alarm. Settable output on/off delay. Intended for wall or ceiling mounting.

IR24-P is a presence detector designed for automatic ventilation control of HVAC systems.



MicroREX D21 Plus Time Switch

Art no: 17822

The MicroREX D21 is a digital 7 day time switch with a circular segmented display for general rail mounting use or on walls in a box, included. Up to 8 program pictures can be set. A program picture incorporates both ON and OFF time. If no button is pressed for 60 seconds during programming the time switch goes back to the start position.

The copying function enables program to be copied to other days. Minimum switching time is 1 minute. The switching times are protected but can be overlaid by other programs. Programs are displayed with a minimum segment size of 30 minutes. The time and the week days are presented digitally. The summer-/winter changeover can be programmed for hand or automatic operation. Plastic housing for easy wall mounting, is available. Spring reserve 6 years.

Ventilation accessories



FK 315 Fast clamp

Art no: 1613
Fast clamps

Mounting clips which facilitate the installation and removal of fans for service and cleaning. Made from galvanised sheet steel and fitted with an 8 mm neoprene lining which suppresses vibrations and ensures a tight fit. The mounting clips are clamped together by two screws which allow for small differences in dimension.



VKK-315 Back draft damper

Art no: 1628

Back draft damper for installation in horizontal ducts. The profiled vanes produce a strong upward force which reduces the air resistance. This means that the vanes opens fully at low air velocities as well. The box is manufactured from galvanised sheet steel. The damper inside the box is manufactured in weather-resistant and shock-proof nylon material. The robust construction ensures that the vanes will not become deformed or loose. Air velocity should not exceed 12 m/s.



VBF 315 Water heating battery

Art no: 1734

Water-heating battery with integral EU5 bag filter for heating air in ventilation systems with circular ducts. Casing from galvanised sheet steel, with copper tubes and aluminium fins. Inspection cover which facilitates cleaning and replacing the filter.

The water-heating battery must be installed in a horizontal duct. The bag filter must always be fitted vertically. The VBF is fitted with connections for connecting to a filter monitor.

The Systemair fan selection programme includes a special selection programme for water-heating batteries. The recommended final pressure drop is 200 Pa.



FFR 315 Filter cassette

Art no: 1779

Filter cassette for circular ducts

The FFR filter cassette is designed for bag filters of the F3, F5 or F7 standard filter types. The cassette is manufactured from galvanised sheet steel with rubber-sealed circular connections and locks with toggle fasteners.

The cassette is fitted with connections for connecting to a pressure sensor. The filters for FFR are BFR bag filters. Available in the F3, F5 or F7 filter classes and are ordered separately and supplied individually. The recommended final pressure drop is 170 Pa for the F3 filter, 200 Pa for the F5 filter and 250 Pa for the F7 filter.



FGR 315 Filter cassette G3

Art no: 1818

Filter cassette for circular ducts

The FGR filter cassette is fitted with a standard type F3 panel filter. The cassette housing is manufactured from galvanised sheet steel with rubber-sealed circular connections, toggle locks and disposable filters. Replacement PFR filters are sold in packs of five.



CWK 315-3-2,5 Duct cooler, circ

Art no: 30025

CWK water-cooling battery for circular ducts

Casing of galvanised sheet steel with copper tubes and aluminium fins. Inspection covers for easy cleaning and maintenance.

Connection sleeves with rubber seal.

Max operating temperature 150 °C
Max operating pressure 1,6 MPa (16Bar)

Ventilation accessories



LDC 315-900 Silencer

Art no: 5197

Silencer

Easily-fitted silencer for circular ducts, fitted with a connection that complies with the spiral duct standard. The LD effectively reduces noise in the duct. Two silencers can be used together in installations where noise reduction is a particularly strong requirement. This is very effective. For the most effective noise reduction, the silencer should be fitted immediately behind a fan or bend. The silencer should be used together with an insulated fan where there is a requirement for noise reduction both in the duct and in the surroundings as a whole. Insulation thickness 50 mm.



CB 315-6,0 400V/2 Duct heater

Art no: 5374

Electrical duct heater

Duct heater with spigot connection for standard spiral ducts. Manufactured from Aluzinc-coated sheet steel with a heating element in stainless steel. The heater has integral overheating protection with a manual reset function. The CB heater has rubber seals on the connecting spigots. Suitable for control by room thermostat or Pulser. The minimum air volume is based on a minimum air velocity of 1.5 m/s. These duct heaters are designed for a maximum output air temperature of 50°C. The CB can be installed in a horizontal or vertical duct. In a horizontal duct, the connection box should be installed facing upwards, or rotated 90° to one side. Installation with the connection box facing downwards is not allowed.



CB 315-9,0 400V/3 Duct heater

Art no: 5375

Electrical duct heater

Duct heater with spigot connection for standard spiral ducts. Manufactured from Aluzinc-coated sheet steel with a heating element in stainless steel. The heater has integral overheating protection with a manual reset function. The CB heater has rubber seals on the connecting spigots. Suitable for control by room thermostat or Pulser. The minimum air volume is based on a minimum air velocity of 1.5 m/s. These duct heaters are designed for a maximum output air temperature of 50°C. The CB can be installed in a horizontal or vertical duct. In a horizontal duct, the connection box should be installed facing upwards, or rotated 90° to one side. Installation with the connection box facing downwards is not allowed.



CB 315-3,0 230V/1 Duct heater

Art no: 5386

Electrical duct heater

Duct heater with spigot connection for standard spiral ducts. Manufactured from Aluzinc-coated sheet steel with a heating element in stainless steel. The heater has integral overheating protection with a manual reset function. The CB heater has rubber seals on the connecting spigots. Suitable for control by room thermostat or Pulser. The minimum air volume is based on a minimum air velocity of 1.5 m/s. These duct heaters are designed for a maximum output air temperature of 50°C. The CB can be installed in a horizontal or vertical duct. In a horizontal duct, the connection box should be installed facing upwards, or rotated 90° to one side. Installation with the connection box facing downwards is not allowed.



CB 315-12,0 400V/3 Duct heater

Art no: 5387

Electrical duct heater

Duct heater with spigot connection for standard spiral ducts. Manufactured from Aluzinc-coated sheet steel with a heating element in stainless steel. The heater has integral overheating protection with a manual reset function. The CB heater has rubber seals on the connecting spigots. Suitable for control by room thermostat or Pulser. The minimum air volume is based on a minimum air velocity of 1.5 m/s. These duct heaters are designed for a maximum output air temperature of 50°C. The CB can be installed in a horizontal or vertical duct. In a horizontal duct, the connection box should be installed facing upwards, or rotated 90° to one side. Installation with the connection box facing downwards is not allowed.



VBC 315-2 Water heating batt

Art no: 5461

Water-heating battery for heating air in ventilation systems with circular ducts. Aluzinc-coated casing, heat transmission element with copper tubes and aluminium fins. Removable cover for cleaning the unit.

The water-heating battery can be installed in a horizontal or a vertical duct with optional direction of airflow.

Max operating temperature 150 °C
Max operating pressure 1,6 MPa (16Bar)
2-rows battery

Ventilation accessories



CBM 315-9,0 400V/3 Duct heater

Art no: 5485

Duct heater with integral control equipment

Duct heater with spigot connection for standard spiral circular ducts. Manufactured from Aluzinc-coated sheet steel with a heating element in stainless steel. The heater has integral overheating protection with a manual reset function. The CBM have rubber seals on the connecting spigots. The temperature is set on the cover of the duct heater. The unit is controlled by an integral electronic temperature regulator, using so-called time-proportional Pulse/Pause technology. This provides extremely precise temperature control. As a thyristor is used for adjusting the temperature, the unit has no moving parts. This means that it is silent and not susceptible to wear and tear. Terminals for interlocking the heater, via a pressure- and airflow guard are available in the terminal box. The minimum air volume is based on a minimum air velocity of 1.5 m/s. These duct heaters are designed for a maximum output air temperature of 50°C.

All CBMs are delivered with duct sensor TG-K330 (0-30°C) as standard.



RSK-315 Back draft damper

Art no: 5604

Back draft damper

Back draft damper for circular ducts, manufactured from galvanised sheet steel. The two blades are spring-loaded, which means that the damper can also be mounted vertically.

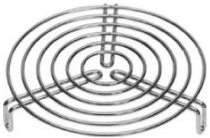

SG 315 Protection guard

Art no: 5611

Protection grille for duct fans, mounted with three screws.



VK-30 Louvre shutter

Art no: 5641

Louvre shutter

Louvre shutters for vertical mounting on a wall. The profiled vanes produce a strong upward force which reduces the air resistance. This means that the vanes opens fully at low air velocities as well.

All the parts are manufactured in weather-resistant and shockproof nylon material (PVC containing special synthetic). The robust construction ensures that the vanes will not become deformed or loose.

Above size 45, the vanes are fitted with a cast counterweight. Air velocity should not exceed 12 m/s. Maximum allowed temperature is 60 °C. The louvre shutters are easy to install. Wall plugs and screws are included above size 15.



Systemair Sdn Bhd (816114-X)
Lot 1565, Kampung Jaya Industrial Area
Jalan Kusta, 13 1/2 Miles, Sungai Buloh
47000 Selangor Darul Ehsan, Malaysia

Tel : +603 615 711 77

Fax : +603 615 666 18

info@systemair.my

www.systemair.my

K SILEO MARCH 2016